



SWIM SPA
COLLECTION
WITH ADAM PEATY

JACUZZI® SWIM SPA COLLECTION



ADAM PEATY'S GARDEN INSTALLATION

THE HERITAGE OF THE JACUZZI® BRAND

Legendary for performance, reliability and ease of use, we set the standard by which all hydrotherapy is measured. While imitation may be the sincerest form of flattery, only 60 years of innovation can produce swim spa designs made to the demanding standards of the Jacuzzi® Brand.



Jacuzzi Brand products are manufactured in five countries and enjoyed across more than 100 countries, employing thousands of people the world over. Representing decades of innovation, design, performance and ease of use, the Jacuzzi® Brand is trusted by millions of customers globally.



SWIM SPAS



HOT TUBS



COMMERCIAL



BATH TUBS

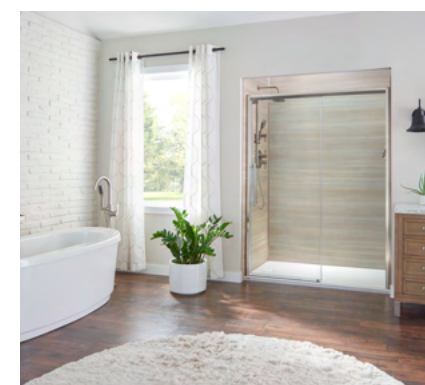

SHOWERS



SAUNAS

HERITAGE

When the seven Jacuzzi brothers immigrated to America, they had no idea that a pump they designed for orchards would revolutionise hydrotherapy in the home. While the family's critical need to change the life of a child triggered this therapeutic invention, a desire for wellness founded an industry.



CELEBRATING
60
YEARS
OF HYDROTHERAPY



The Jacuzzi family departs Italy for the United States and transforms the aviation and agriculture industries.



When Ken Jacuzzi, age 2, is diagnosed with rheumatoid arthritis, his father invents a portable hydrotherapy pump to provide pain-relieving hydrotherapy.



Jacuzzi soon became a household name thanks in part to repeated appearances on the national daytime television show, Queen for a Day, which boasted 20 million viewers. The Jacuzzi® Brand became an overnight sensation.



Through the years, the Jacuzzi® Brand has been awarded more than 700 patents, laying our foundation for unmatched hydrotherapy and leading to breakthroughs in jet engineering, design, and technology.



With a foundation in health and wellness and a dedication to research and innovation, Jacuzzi continues to develop products that improve the lives of both high-performance athletes and everyday people while leading the industry as the most recognized brand in the world.

PERFORMANCE

Jacuzzi® premium products support the needs of high endurance athletes and teams who are committed to maintaining and improving their quality of life, both during and beyond their active careers through the power of hydrotherapy. Whether you're a professional athlete or a weekend warrior, Jacuzzi® products increase your ability to train, recover, relax and perform, harnessing water's natural ability to heal the mind, body and soul.

The Jacuzzi® Brand proudly partners with endurance athletes and professional teams around the world.



ADAM PEATY
Olympic Gold Medalist and
World Record Holder - GB Swimming



KIMBERLEY MORRISON
Triathlete and Ironman Champion



JESSICA JANE APPEGATE
Paralympic Champion - GB Swimming



HULL FC
Super League Team - Rugby League



SALLY GUNNELL
Olympic Gold Medalist - Athletics



JOE FRASER
World Champion - GB Gymnastics



ADAM PEATY

TRAIN LIKE A PRO WITH A JACUZZI® SWIM SPA

ADAM PEATY

As one of the best breaststroke swimmers to ever grace the pool, his legacy is still being written: repeat top spots on the podium on the global competitive stage and a knack for breaking world records for fun, his attitudes towards training, performance and recovery is second to none. After stepping in to keep his training for Tokyo on track with the donation of a swim spa at the time of 2020's lockdown, bringing Adam on board as a proud ambassador seemed the natural next step.



ADAM'S 100M BREASTSTROKE WORLD RECORDS

- **58.18**
2015 World Championships, Kazan
- **57.92**
2015 British Championships
(First person to swim under 58 seconds)
- **57.13**
2016 Olympics, Rio
- **57.79**
2017 British Championships
- **57.47**
2017 World Championships, Budapest
- **57.10**
2018 European Championships, Glasgow
- **56.88**
2019 World Championships, Gwangju
- **55.49**
2020 International Swimming League
- **55.41**
2020 International Swimming League

ADAM'S MEDALS

- 1 Olympic Gold Medal
- 1 Olympic Silver Medal
- 3 Commonwealth Games Gold Medals
- 3 Commonwealth Games Silver Medals
- 8 World Championship Gold Medals
- 12 European Championship Gold Medals



WHAT KIND OF SWIMMER ARE YOU?



SWIMMER - POWERPRO™

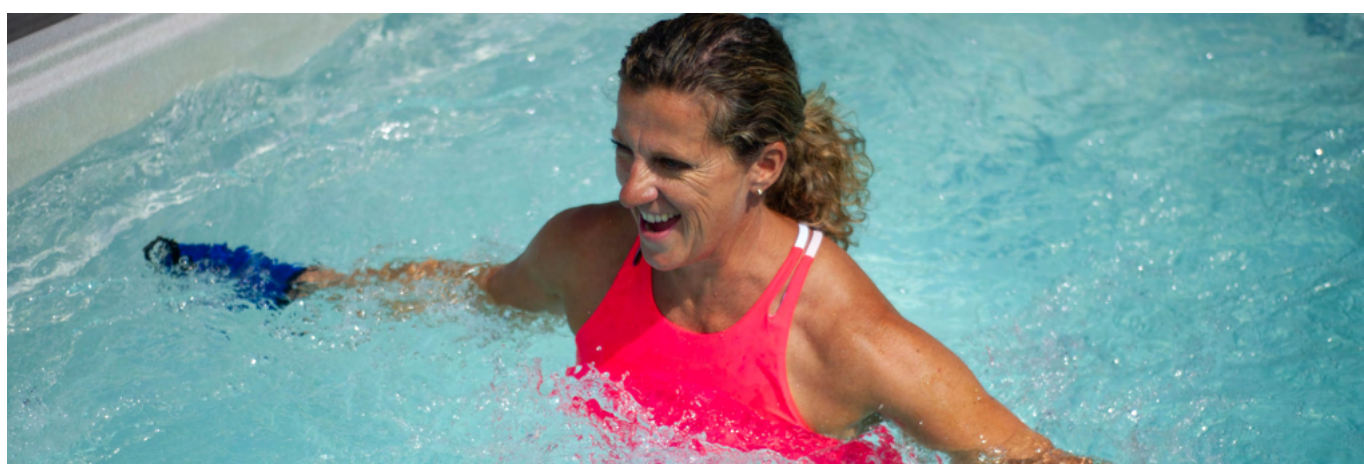

FITNESS POOLS - POWERACTIVE™



FAMILY TIME - POWERPLAY™

	FAMILY TIME - POWERPLAY™	FITNESS POOLS - POWERACTIVE™	SWIMMER - POWERPRO™
SWIM FEATURES	PowerPlay™ Swim Jets	PowerActive™ Swim Jets	Adjustable PowerPro™ Swim Jets
		SteadySwim™ Bouyancy Jet	SteadySwim™ Bouyancy Jet
		SmoothSwim™ Shell Design	SmoothSwim™ Shell Design
MASSAGE	Up to 9 seats Mixed Hydromassage and Bench	4 x PowerPro™ Hydromassage Seats	4 x PowerPro™ Hydromassage Seats
EASE OF USE	Illuminated Control Panel	ProTouch™ Touch Screen Control Panel	ProTouch™ Touch Screen Control Panel
	2-Stage Filtration System	4-Stage Filtration System	4-Stage Filtration System
		CLEARRAYActive Oxygen™ Clean Water System	CLEARRAYActive Oxygen™ Clean Water System
FITNESS	Soft Stride mat for no-slipaquatic exercise	Soft Stride mat for no-slipaquatic exercise	Soft Stride mat for no-slipaquatic exercise
		FORM Goggles	FORM Goggles
		Rowing Kit, Aquatic Fitness Package, Exercise Bar Upgrade Options	Rowing Kit, Aquatic Fitness Package, Exercise Bar Upgrade Options

PRECISION SWIM

The best high-performance swim experience combines the latest aquatic technology with the expertise of Jacuzzi® PowerPro™ Jets for a predictable swim.

BALANCED SWIM JETS

Adjustable flow of the swim jets produces consistently smooth water simultaneously, so that you can maintain a steady swim without being pushed out of your swim lane.

REFLECTIVE HIPS

A unique shell design incorporates hips to stop reflective waves, so you can always enjoy the perfect swim.

FLOW RETURN SUCTIONS

Suctions towards the back of the swim spa pull the flow of water for a more predictable current.

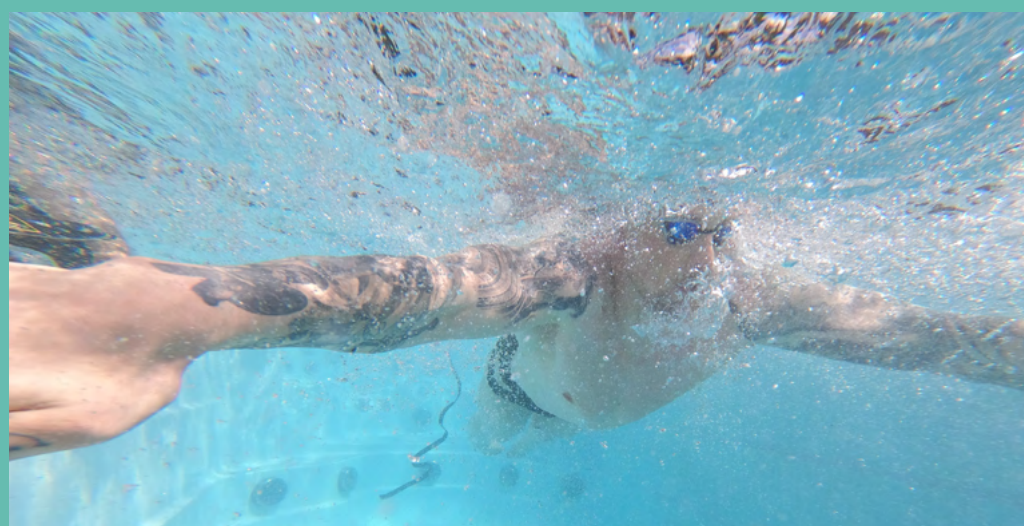

STEADYSWIM™ BUOYANCY JET

A unique buoyancy jet combines just the right amount of air with an extremely predictable current to help elevate you into the proper body position so you can focus on perfecting your stroke.



HYDROMASSAGE

The combination of versatile PowerPro™ Jets, and our ergonomically designed seats, our products deliver an adjustable high-flow, low-pressure hydromassage and a powerful swim experience.

PERSONALISED MASSAGE

To ensure you experience an optimal massage, our swim spas are engineered using dimensions from the average measurements of 90% of the population.

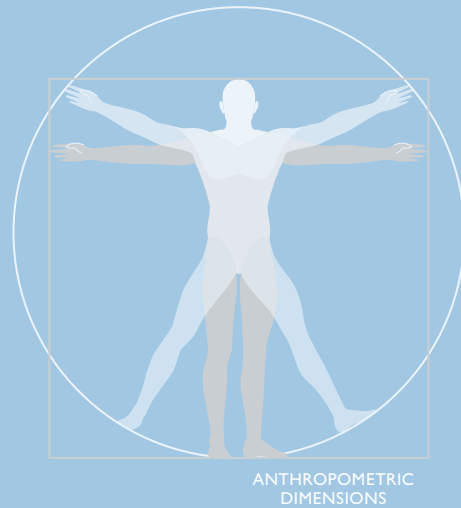

ERGONOMIC SEATING

Seats designed to follow the contours of the body and recessed jets placed to perfectly match the muscle structure of the human form delivers a comfortable, premium hydromassage experience for most body types.

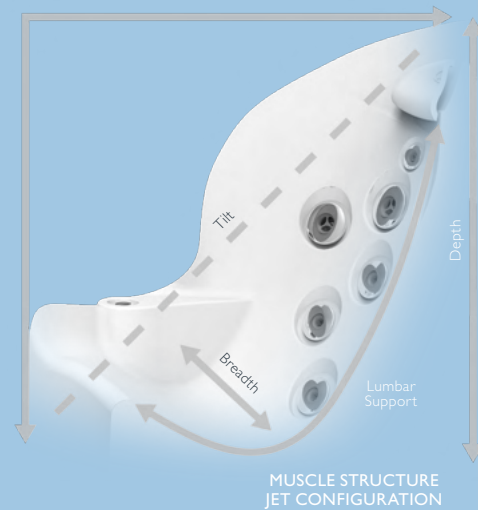

COMPLETE BALANCE

Using the Aqualibrium® Formula, each jet is individually calibrated to deliver the perfect balance of air and water, then precisely paired with the exact pump-to-jet ratio needed to ensure a balanced experience in each and every seat.

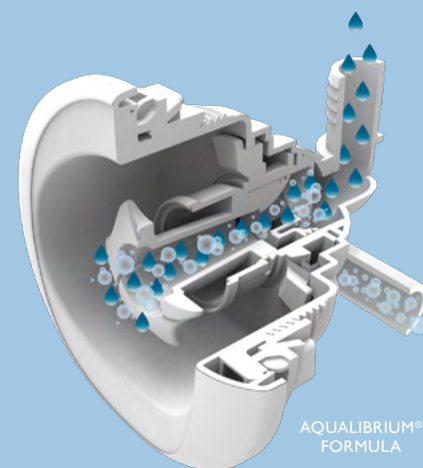

Jacuzzi® Swim Spas feature four seats designed to follow the contours of the body. Adjustable pillows and recessed PowerPro™ jets placed to perfectly match key muscles used to swim deliver a comfortable, premium hydromassage experience.



RX JET THERAPY SEAT

Targeting common swim muscles, the spinning RX jet seat delivers comforting relief to the back and neck utilizing the highest performance hydromassage the Jacuzzi® Brand offers.



FX THERAPY SEAT

Alleviating swimmer's soreness in the neck, shoulders and back, the full coverage massage seat delivers a deep, adjustable, rifling, spiral stream of air and water.





CLEAN WATER

CLEARRAY Active Oxygen™ technology harnesses the power of air and light to work harder and clean the water longer. It's an advanced oxidation process that destroys contaminants and waterborne pathogens.

UV-C SYSTEM

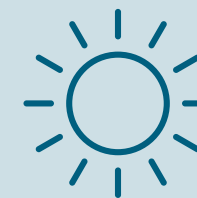

Nature-inspired technology neutralises pathogens
 Works with traditional chlorine or bromine sanitiser for sensitive skin
 Same technology used in bottled drinking water, aquariums, and hospitals

OUR HANDS-FREE APPROACH TO WATER CARE

Ozone + UV-C
 Active Oxygen



4-STAGE FILTRATION PROCESS*

- STAGES
1 & 2

The surface skimming weir and ProCatch™ bag work together to clean the surface while trapping large debris for easy removal.
- STAGE
3

Two ProClear® filters help ensure clean, sparkling water quickly by catching tiny debris and particles that other filters miss.
- STAGE
4

The ProStream™ circulation pump pulls the water through a ProClear® filter that works to clarify water even when the jets are not running.

*Stages of filtration may vary by model

QUALITY

Jacuzzi® Swim Spas are designed for reliability, both inside and out. We believe that quality is only as good as the people, processes and parts behind the products. That's why our products are exceptionally engineered with the best materials to ensure an exceptional product.



ENERGY EFFICIENT ENGINEERING

The combination of a strong shell, foam insulation, SmartSeal™ insulation, insulated floor and fully-adjustable venting help boost eco-efficiency.

PROFUSION™ SHELL

Three layers of material for a strong, scratch-resistant shell.

FOAM INSULATION

An air, moisture, and sound barrier adding structural integrity to pipes.

SMARTSEAL™ TECHNOLOGY

Heat-reflecting insulation made for the coldest winters.

REFLECTIVE HIPS

Shell design helps stop reflective waves for consistently smoother water

POWERPRO™ JETS

Jacuzzi exclusive Hydromassage technology

PROLAST™ COVERS

Custom fit to lock in heat and improve energy efficiency and safety

PROFUSION™ SHELL

Three layers for a strong, scratch-resistant shell

GALVANISED STEEL FRAME

Designed for durability and increased structural support

ENERGY EFFICIENT FOAM INSULATION

Retains heat, absorbs noise, and supports plumbing

DURABLE PROPOLYMER™ BASE

Impervious to nature and moisture, and makes installation easy

PROENDURE™ SYNTHETIC CABINETRY

Stunning, durable, synthetic cabinetry

THE ALL-SEASONS POOL

Jacuzzi® Swim Spas are engineered to be the most energy efficient swim spas in the world. Offering the perfect alternative to a traditional swimming pool, swim spas are an easy way to swim, workout, or just have fun all year long.

Swim spas are also very versatile when it comes to installation. Whether you choose to create an above-ground decked garden retreat, or sunken family-time sanctuary, your year-round pool can be installed just about anywhere.



INNOVATION

Compatible with wearable technology calibrated specifically for Jacuzzi® Swim Spas, the FORM Smart Swim Goggles not only track and analyse your results; you can view these stats in real-time on your optical display thanks to smart technology. An app also tracks stats and lets you analyse results and customise your swimming routine, all at your convenience, at home.



FORM SMART SWIM GOGGLES

Wearable technology calibrated specifically for Jacuzzi® PowerPro™ and PowerActive™ Swim Spas

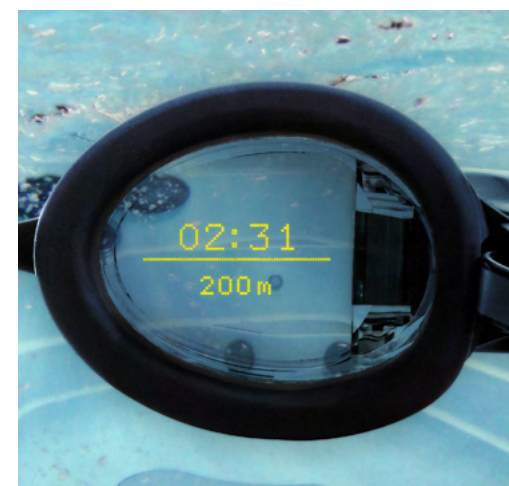

TRACK AND ANALYSE RESULTS



- Optical display using smart technology
- Real-time analytics on your optical display (time, distance, pace, optional heart rate)
- Consistent feedback allows for uninterrupted workout



IN-APP GUIDANCE



- Track stroke rate, calories, time, distance and workouts
- Customise your swimming routine
- Workout in the convenience of home



COMPREHENSIVE FITNESS ALTERNATIVE



- Engage with other swimmers in the app
- Share workouts and results on social
- Use for swim and resistance training for all fitness levels



Take your swimming to the next level,
whatever your ability!

AP Race Plus is a swimming-specific online support platform that has been built by world class experts with over a century of combined experience to help swimmers of all types maximise their potential.

One year's AP Race Plus licence per household is FREE for every Jacuzzi® Swim Spa owner.

AP RACE PLUS



Swim

AP Race Plus helps swimmers understand what you do in the pool and why to do it.

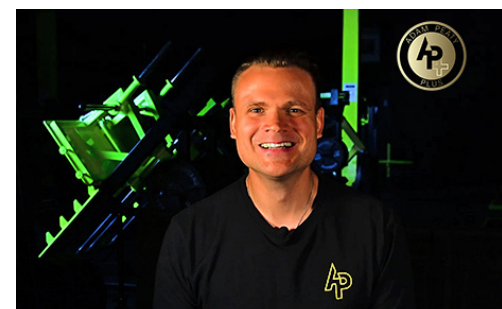

Strength & Conditioning

AP Race Plus focuses on the muscles and motor pathways needed to build strong foundations for swimming.



Nutrition

AP Race Plus teaches what foods to eat for improved performance and recovery, and why we should eat them.



Psychology

AP Race Plus shares the techniques required to think like a champion before you even set foot in the water.



Parent support

AP Race Plus guides you on how to effectively support your young swimmer through their swimming journey.

Throughout the course of AP Race Plus, Adam Peaty shares the invaluable insight he has gained and the lessons he has learnt along his swimming journey so far.

POWERPRO™ COLLECTION



ADAM PEATY'S GARDEN INSTALLATION

POWERPRO™

SWIM SPA COLLECTION

FEATURES:

- FORM Goggles Wearable Technology
- Swim Selector Control
- ProTouch™ Control
- PowerPro™ Jets
- PowerPro™ PX Swim Jets
- SteadySwim™ Buoyancy Jet
- CLEARRAY Active Oxygen™ Clean Water System
- Multi-stage Filtration
- Quick Drain System
- Soft Stride Mat
- Illuminated Waterfall
- Premium LED Lighting
- Adjustable Headrests
- Status Indicator Light

OPTIONAL FEATURES:

- Auxiliary Heater By-Pass Loop
- Solid State Frame Only - No Cabinet
- Rowing Kit
- 48" Exercise Bar
- Aquatic Fitness Package



PERFORMANCE

- Adjustable PowerPro™ PX swim jets for every level, from beginners to triathletes
- SteadySwim™ buoyancy jet keeps swimmers aligned by elevating you into the proper body position
- An unprecedented four 3Hp pumps produce a powerful velocity of water for premium swim blade and hydrotherapy performance



DESIGN

- A unique SmoothSwim™ shell design incorporates hips in the shell to stop reflective waves and keep you in your swim lane
- Stunning, durable, synthetic wood cabinetry
- Return suctions located at the opposite end of swim blades eliminate turbulence, producing a conveyor belt-like swim system for a smoother swim



EASE OF USE

- Soft Stride mats allow you to enter and exit the swim spa safely
- An at-a-glance status indicator light that changes colors when your swim spa needs attention
- An exclusive swim selector control near the swim blades let you adjust your experience at the touch of a button, from swim current speed to preprogrammed workout mode

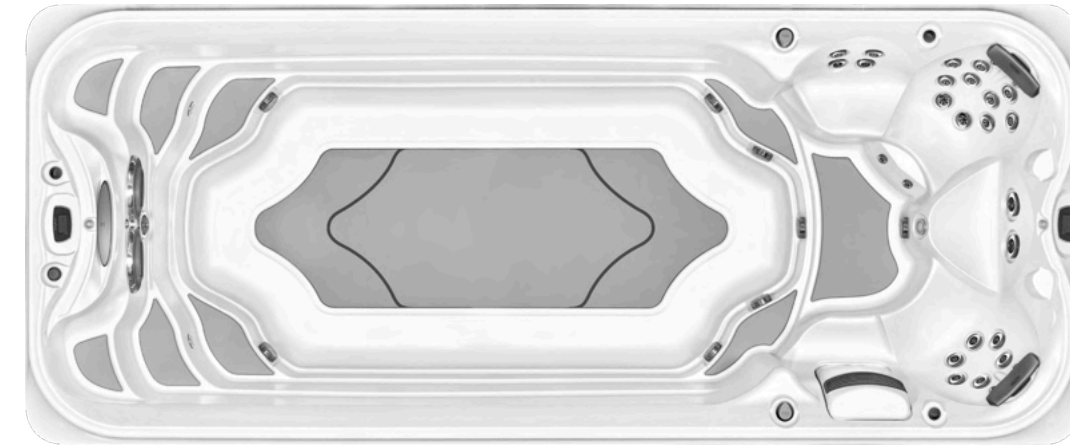

J-19™

DIMENSIONS*

564 cm x 236 cm x 135 cm

USABLE SWIM AREA

376 cm

DRY WEIGHT

1,374 kg

TOTAL FILLED WEIGHT

10,412 kg

AVERAGE SPA VOLUME

9,038 liters

PUMP 1

3HP/2SPD/10/3A (UK)

PUMP 2

3HP/2SPD/10/3A (UK)

PUMP 3

3HP/2SPD/10/3A (UK)

PUMP 4

3HP/2SPD/10/3A (UK)



J-16™

DIMENSIONS*

472 cm x 236 cm x 135 cm

USABLE SWIM AREA

284 cm

DRY WEIGHT

1,162 kg

TOTAL FILLED WEIGHT

8,799 kg

AVERAGE SPA VOLUME

7,638 liters

PUMP 1

3HP/2SPD/10/3A (UK)

PUMP 2

3HP/2SPD/10/3A (UK)

PUMP 3

3HP/2SPD/10/3A (UK)

PUMP 4

3HP/2SPD/10/3A (UK)

ACRYLIC OPTIONS



Platinum

CABINETRY COLORS



Smoked Ebony



Brushed Grey

PROLAST™ COVERS

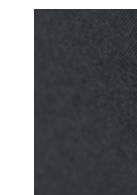

Grey

*All swim spa dimensions are shown in: L x W x H.

POWERACTIVE™ COLLECTION



POWERACTIVE™

SWIM SPA COLLECTION

FEATURES:

- FORM Goggles Wearable Technology
- ProEndure™ Cabinetry
- ProTouch™ Control
- PowerPro™ Jets
- PowerActive™ AX Swim Jets
- SteadySwim™ Buoyancy Jet
- CLEARARRAY Active Oxygen™ Clean Water System
- Multi-stage Filtration
- Quick Drain System
- Soft Stride Mat
- Illuminated Waterfall
- Premium LED Lighting
- Adjustable Headrests
- Status Indicator Light

OPTIONAL FEATURES:

- Auxiliary Heater By-Pass Loop
- Solid State Frame Only - No Cabinet
- Rowing Kit
- 48" Exercise Bar
- Aquatic Fitness Package

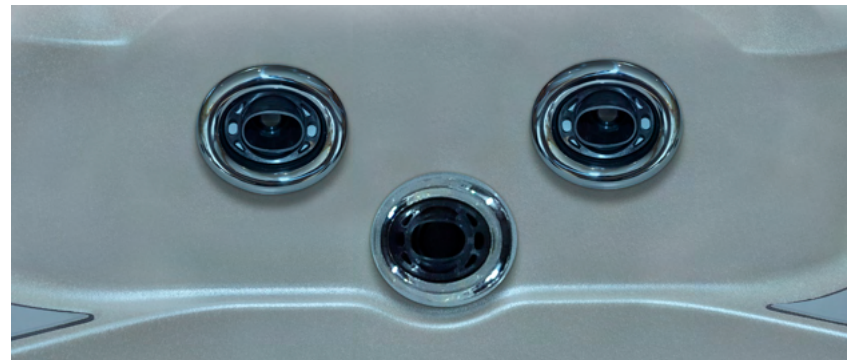

PERFORMANCE

- PowerActive™ AX swim jets deliver a smooth, spacious current for in-place swimming
- SteadySwim™ buoyancy jet keeps swimmers aligned by elevating you into the proper body position
- Together, a 4Hp and 3Hp pump produce a strong velocity of water for quality swim current and hydrotherapy performance



DESIGN

- A unique SmoothSwim™ shell design stops reflective waves, so you can always enjoy the perfect swim
- Stunning, durable, synthetic wood cabinetry
- Return suction located at the opposite end of swim jets eliminate turbulence, producing a conveyor belt-like swim system for a smoother swim



EASE OF USE

- Soft Stride mats allow you to enter and exit the swim spa safely
- An at-a-glance status indicator light that changes colors when your swim spa needs attention
- A ProTouch™ control lets you turn on your swim jets and adjust your hydrotherapy experience at the tap of a button

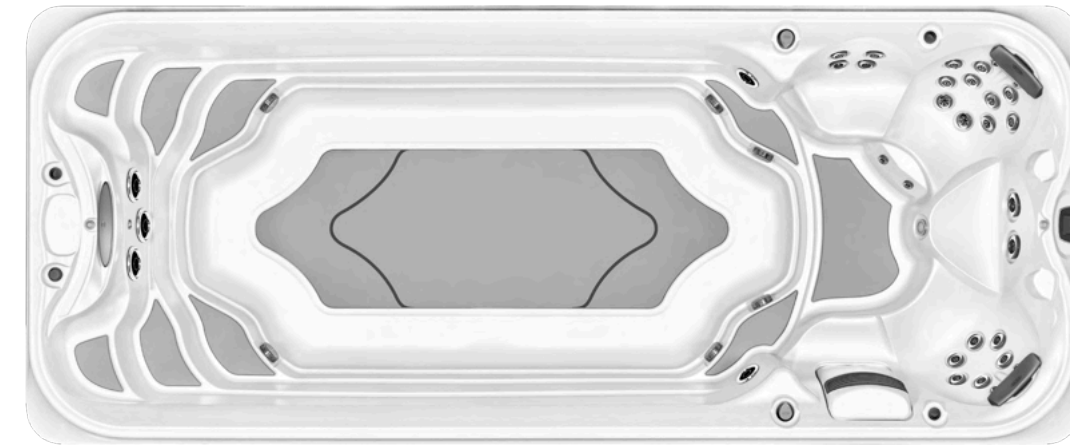

J-19™

DIMENSIONS*
564 cm x 236 cm x 135 cm

USABLE SWIM AREA
376 cm

DRY WEIGHT
1,374 kg

TOTAL FILLED WEIGHT
10,412 kg

AVERAGE SPA VOLUME
9,038 liters

PUMP 1
3HP/2SPD/10/3A (UK)

PUMP 2
4HP/1SPD/12.7A (UK)



J-16™

DIMENSIONS*
472 cm x 236 cm x 135 cm

USABLE SWIM AREA
284 cm

DRY WEIGHT
1,162 kg

TOTAL FILLED WEIGHT
8,799 kg

AVERAGE SPA VOLUME
7,638 liters

PUMP 1
3HP/2SPD/10/3A (UK)

PUMP 2
4HP/1SPD/12.7A (UK)

ACRYLIC OPTIONS



Platinum

CABINETRY COLORS

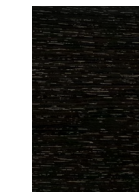

Smoked
Ebony

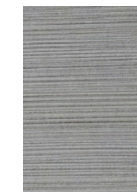

Brushed Grey

PROLAST™ COVERS

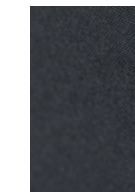

Grey

*All swim spa dimensions are shown in: L x W x H.

POWERPLAY™ COLLECTION

POWERPLAY™ COLLECTION



POWERPLAY™

SWIM SPA COLLECTION

FEATURES:

- ProFinish™ Cabinetry
- TP 600 Control
- PowerPro™ Jets
- PowerPlay™ CX Swim Jets
- 2-Stage Filtration System
- Quick Drain System
- Soft Stride Mat
- Illuminated Waterfall
- Premium LED Lighting
- Adjustable Headrests
- Status Indicator Light

OPTIONAL FEATURES:

- CLEARRAY Active Oxygen™ Clean Water System
- Auxiliary Heater By-Pass Loop
- Rowing Kit
- Aquatic Fitness Package



PERFORMANCE

- PowerPlay™ CX swim jets deliver a current perfect for an entry-level swim or fitness
- A mix of bench seats and hydromassage seats offer up to nine options to enjoy Jacuzzi® hydrotherapy
- Together, one 3Hp 2-speed pump and two 3Hp single speed pumps produce a consistent velocity of water for quality exercise, fun, and hydrotherapy performance



DESIGN

- Stunning, durable, synthetic wood cabinetry
- Return suctions located at the opposite end of swim jets eliminate turbulence for a smoother swim



EASE OF USE

- Soft Stride mats allow for no-slip aquatic exercise
- An at-a-glance status indicator light that changes colors when your swim spa needs attention
- A streamlined topside control lets you turn on your swim jets and adjust your hydrotherapy experience at the tap of a button



J-13™

DIMENSIONS*

381 cm x 236 cm x 135 cm

USABLE SWIM AREA

244 cm

DRY WEIGHT

981 kg

TOTAL FILLED WEIGHT

6,073 kg

AVERAGE SPA VOLUME

5,093 liters

PUMP 1

3HP/2SPD/10/3A (UK)

PUMP 2

3HP/1SPD/10/3A (UK)

PUMP 3

3HP/1SPD/10/3A (UK)



ACRYLIC OPTIONS



Platinum

CABINETRY COLORS

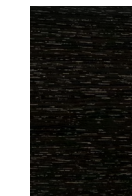

Smoked Ebony



Brushed Grey

PROLAST™ COVERS

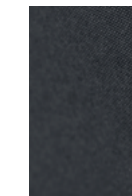

Grey

*All swim spa dimensions are shown in: L x W x H.

ACCESSORIES

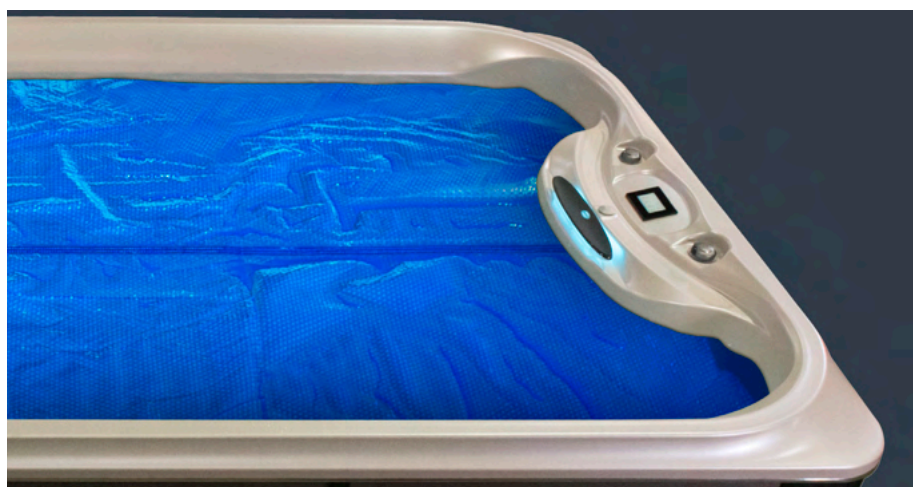

FLOATING COVER WITH TIE DOWNS

Keep your swim spa warm and ready for use, prevent unwanted debris, and conserve energy with a secure floating cover with tie downs. To be used in conjunction with the Alaskan safety cover.



DURABLE STEPS

Made with long-lasting, weather-resistant materials, steps make it easy to enter and exit your Jacuzzi® Swim Spa.



ROLLAWAY COVER

Light, energy-efficient, and easy to use, the next generation of swim spa cover creates a complete seal and can be operated by one person in less than 60 seconds.

FITNESS OPTIONS

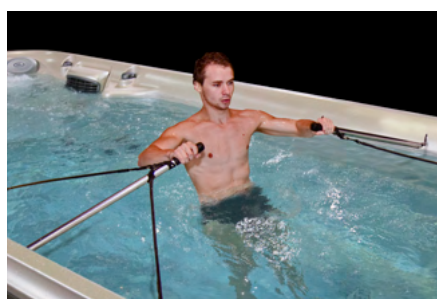

AQUA-ROWING KIT

A combination of stainless steel oars and rubber bands attach to swivel anchors allowing you to accomplish the full rowing motion. This is an excellent upper body and abdominal workout.

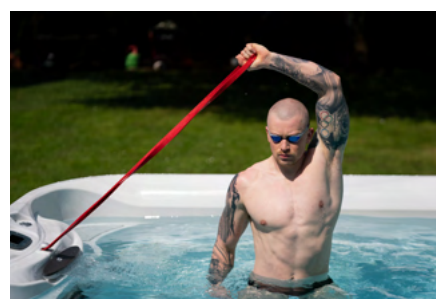

AQUA FITNESS PACKAGE

The addition of this fitness package turns any swim spa into an aquatic universal gym. The resistance bands add another dimension to your workout and can be used anywhere in your swim spa within the exercise or swim tank area.

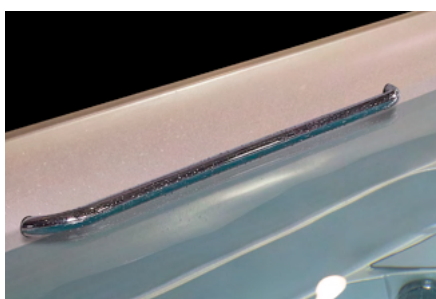

48" EXERCISE BARS

The addition of this wall mounted option allows you to use the swim spa for any rehabilitation or just provide balance when completing aquatic fitness programs. Available on select models.



EASY TO USE
25% lighter than other rolling spa covers



SINGLE-PERSON OPERATION
One person can uncover the swim spa in less than 60 seconds



DURABLE DESIGN
Double-stitched, waterproof, and weather-resistant fabric with non-collapsible supports



www.jacuzzi.co.uk
Jacuzzi Brands UK
Low Road, Old Mill Lane
Leeds, LS10 1RB

©2021 Jacuzzi Hot Tubs. All rights reserved. Jacuzzi® is a registered trademark of Jacuzzi Inc. used with permission. All other brands, product names, company names, trade names, trademarks and service marks used are the property of their respective owners. Jacuzzi Hot Tubs may make product modifications and enhancements. Specifications may change without notice. International products may be configured differently to meet local electrical requirements. Dimensions are approximate. Manufactured under one or more United States patent numbers. Other patents may apply.

